

Datasheet

FS8855

500 mA LDO Linear Regulator

FORTUNE,
Properties
For Reference Only

Fortune Semiconductor Corporation

富晶電子股份有限公司

23F., No.29-5, Sec. 2, Zhongzheng E. Rd.,
Danshui Dist., New Taipei City 251, Taiwan

Tel. : 886-2-28094742

Fax : 886-2-28094874

www.ic-fortune.com

This manual contains new product information. **Fortune Semiconductor Corporation** reserves the rights to modify the product specification without further notice. No liability is assumed by Fortune Semiconductor Corporation as a result of the use of this product. No rights under any patent accompany the sale of the product.

1. General Description

The FS8855 is a low-dropout linear regulator that operations in the input voltage range from +2.5V to +9.0V and delivers 500mA output current.

The high-accuracy output voltage is preset at an internally trimmed voltage 2.5V or 3.3V. Other output voltages can be mask-optioned from 1.5V to 5.0V with 100mV increment,

The FS8855 consists of a 1.25V bandgap reference, an error amplifier, and a P-channel pass transistor. Other features include short-circuit protection and thermal shutdown protection. The FS8855 devices are available in SOT-89 packages.

2. Features

- Low dropout voltage 700mV at 500mA (Typ.)
- Up to ±35mV output voltage accuracy (VIN≤7.0V, VOUT≤3.5V)
- Preset at 2.5V, 3.3V
- Mask options from 1.5V to 5.0V
- Quiescent current 30µA at 5V input (Typ.)
- Small output capacitor
- Output current limit
- Thermal overload shutdown protection
- SOT-89 Package

3. Applications

- CD-ROM Drivers
- DVD-ROM Drivers
- Portable Consumer Equipment
- Radio Control Systems
- Wireless Communication Systems

4. Ordering Information

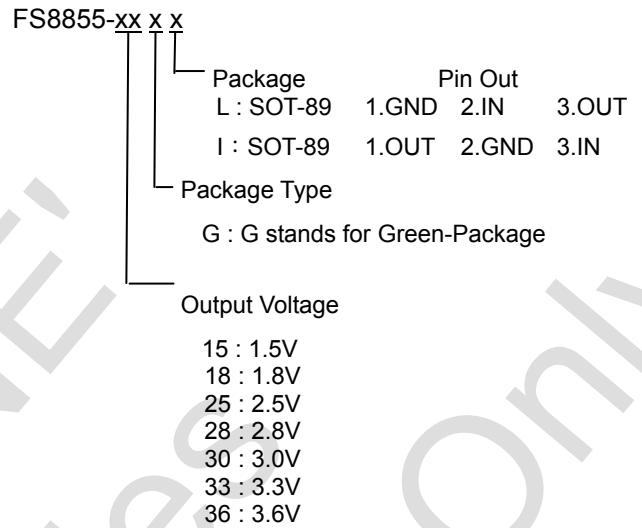

Note : Mask option output types are available by order only

5. Pin Configurations

Part No.	Pin 1	Pin 2	Pin 3
FS8855-xxGL	GND	IN	OUT
FS8855-xxGI	OUT	GND	IN

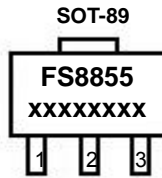

6. Package Marking Information

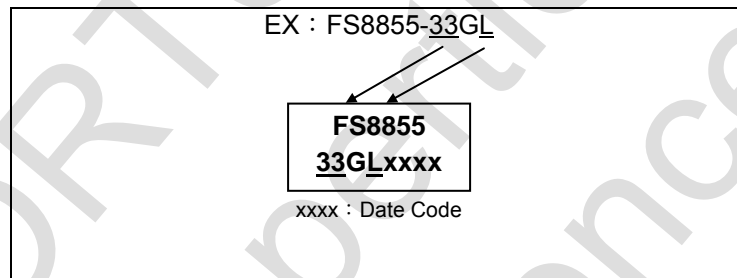

7. Pin Description

Part NO.	Symbol	Description
FS8855-xxGL FS8855-xxGI	GND	Ground pin that provides the reference for all voltages.
	IN	Regulator input pin. Supply voltage can range from 2.5V to 9.0V. Bypass with a 1µF capacitor to GND.
	OUT	Regulator output pin. Sources up to 550mA. Bypass with a 3.3µF capacitor to GND.

8. Functional Block Diagram

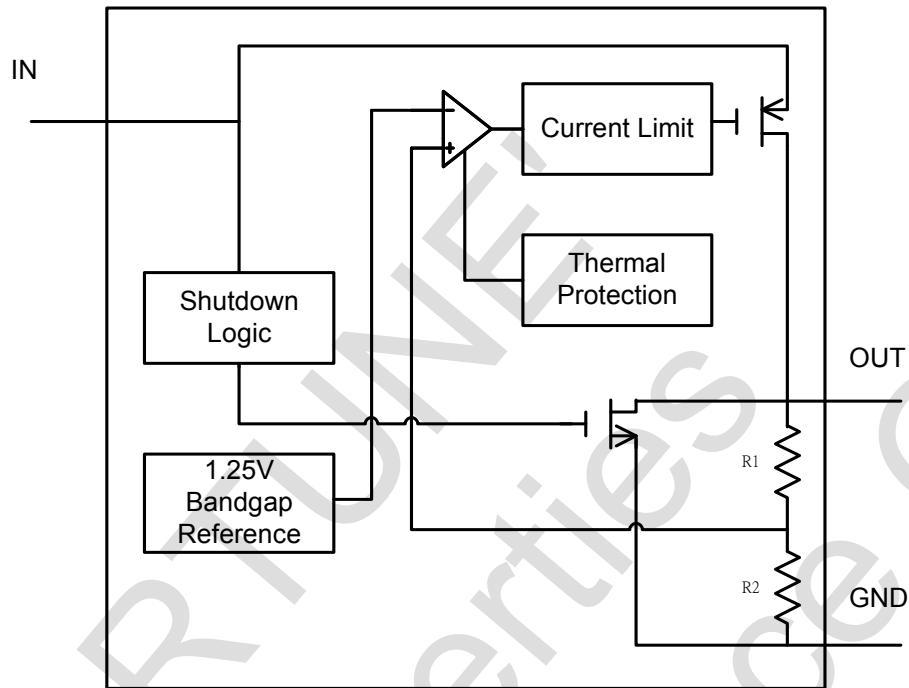

9. Typical Application Circuit

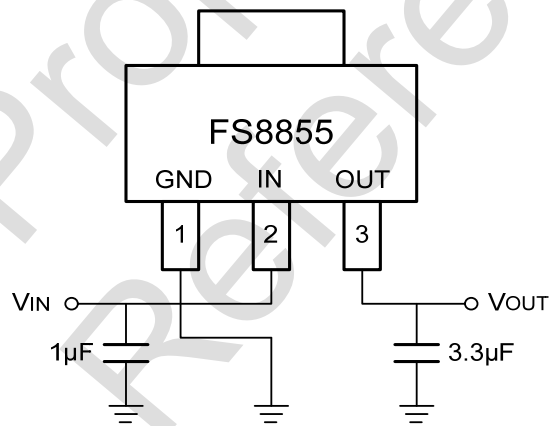

10. Absolute Maximum Ratings

Input voltage VIN to GND 9V
 Output current limit, I(LIMIT) 0.8A
 Continuous power dissipation, PD ($\Delta T = T_J - T_A = 100^\circ\text{C}$)
 SOT-89 0.55W

* The power dissipation values are based on the condition that junction temperature T_J and ambient temperature T_A difference is 100°C .

Junction Temperature, T_J $+155^\circ\text{C}$
 Storage temperature range, TSTG -55°C to $+150^\circ\text{C}$
 Operating junction temperature range -40°C to $+125^\circ\text{C}$
 Lead temperature (soldering, 10sec) 260°C

* Stresses beyond those listed under “absolute maximum ratings” may cause permanent damage to the device. These are stress ratings only, and function operation of the device at these or any other conditions beyond those indicated under “recommended operating conditions” is not implied. Exposure to absolute-maximum-rated conditions for extended periods may affect device reliability

11. Electrical Characteristics

($T_A = 25^\circ\text{C}$, unless otherwise noted.)

Symbol	Parameter	Test Conditions	Min	Typ	Max	Unit
VIN	Input Voltage		2.5		7.0	V
VOUT	Output Voltage Accuracy $1.5\text{V} \leq \text{VOUT} \leq 3.5\text{V}$	$\text{VIN} > \text{VOUT} + 0.8\text{V}$, $\text{IOUT} = 1\text{mA}$, $\text{VIN} \leq 7\text{V}$	$\text{VOUT} - 2.0\%$	VOUT	$\text{VOUT} + 2.0\%$	V
IMAX	Maximum Load Current		500			mA
ILIMIT	Current Limit				0.8	A
ISC	Short-Circuit Current	$\text{VOUT} = 0\text{V}$, $\text{VIN} = 5.0\text{V}$		350	400	mA
IQ	Ground Pin Current	$\text{IOUT} = 0\text{mA}$ to 500mA , $\text{VIN} = 5.0\text{V}$		30	50	μA
VDROP	Dropout Voltage	$\text{IOUT} = 1\text{mA}$		1.1	1.3	mV
		$\text{IOUT} = 100\text{mA}$		140	170	mV
		$\text{IOUT} = 500\text{mA}$		700	850	mV
ΔVLINE	Line Regulation	$\text{VOUT} + 0.8\text{V} < \text{VIN} < 9\text{V}$, $\text{ILOAD} = 1\text{mA}$		0.2	0.3	%/V
ΔVLOAD	Load Regulation	$\text{IOUT} = 0\text{mA}$ to 500mA		0.01	0.02	%/mA
eN	Output Noise	$F = 1\text{Hz}$ to 10kHz , $\text{COUT} = 3.3\mu\text{F}$		75		μVRMS
PSRR	Ripple Rejection	$F = 10\text{kHz}$, $\text{COUT} = 3.3\mu\text{F}$		70		dB
TSD	Thermal Shutdown Temperature			155		$^\circ\text{C}$
THYS	Thermal Shutdown Hysteresis			10		$^\circ\text{C}$
θJA	Thermal Resistance	SOT-89			180	$^\circ\text{C/W}$

12. Typical Operating Characteristics

(C_{IN}=1.0μF, C_{OUT}=3.3μF, T_A=+25°C, unless otherwise noted.)

OUTPUT VOLTAGE vs. INPUT VOLTAGE

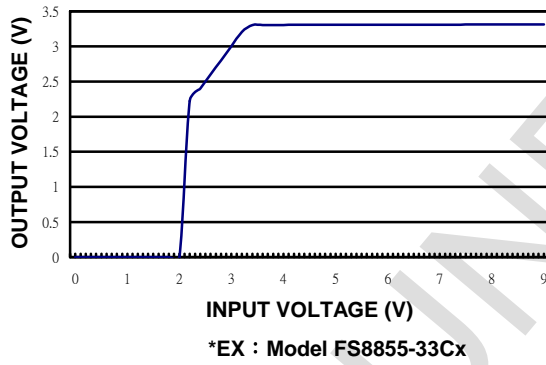

GROUND PIN CURRENT vs. AMBIENT TEMPERATURE

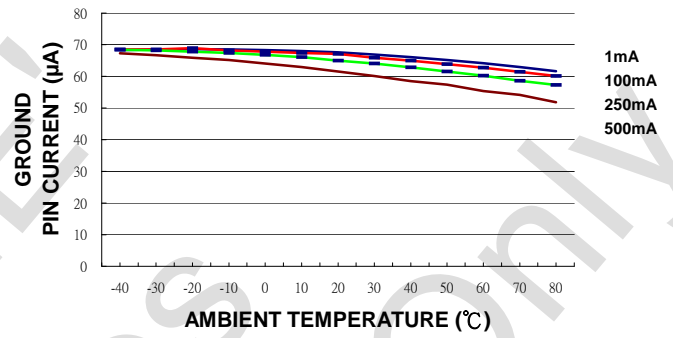

DROPOUT VOLTAGE vs. LOAD CURRENT

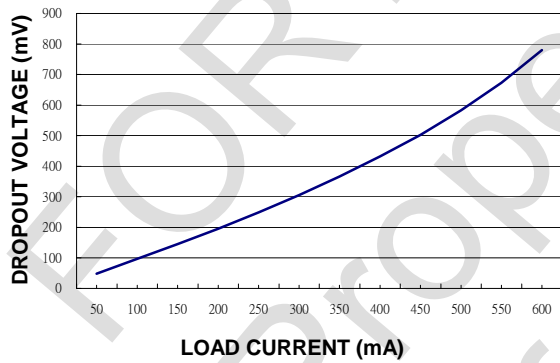

R_{on} vs. LOAD CURRENT

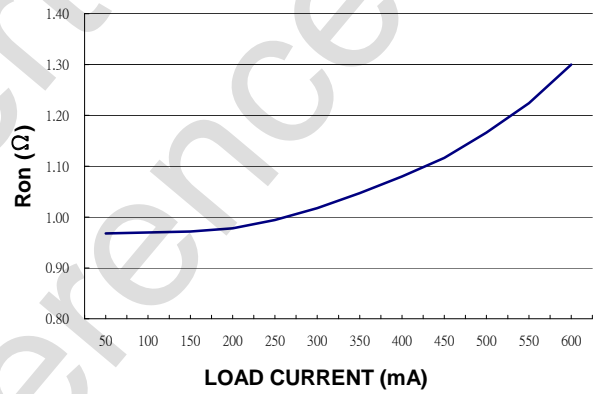

POWER SUPPLY REJECTION RATIO vs. FREQUENCY

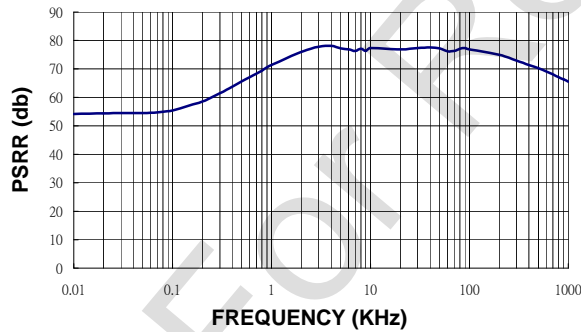

GND PIN CURRENT vs. LOAD CURRENT

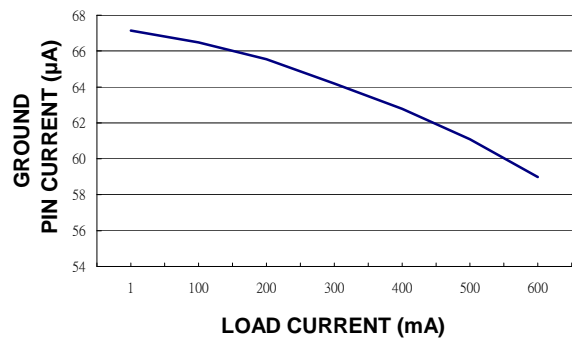

OUTPUT VOLTAGE vs. AMBIENT TEMPERATURE

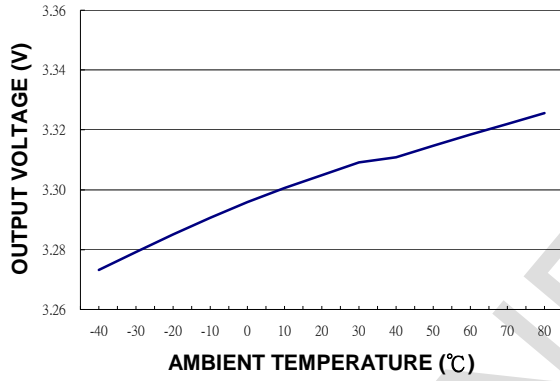

GROUND PIN CURRENT vs. INPUT VOLTAGE

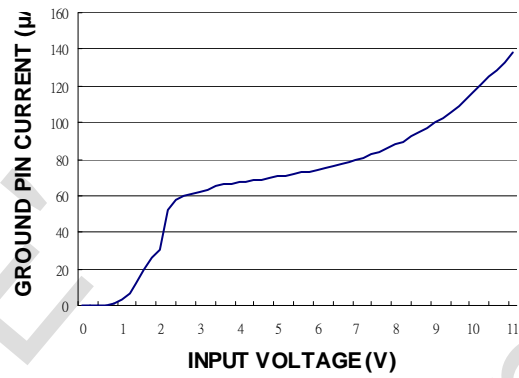

OUTPUT NOISE DC to 1MHz (39µVRMS)

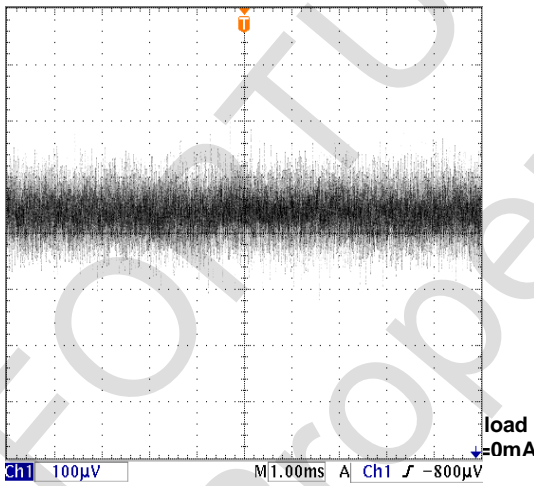

OUTPUT NOISE to 1MHz (74µVRMS)

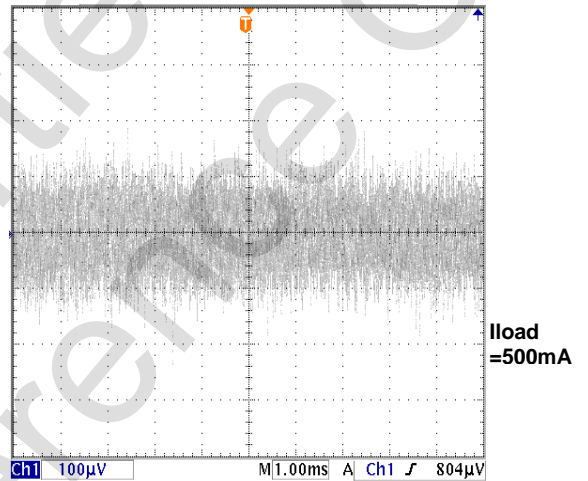

LINE TRANSIENT (I_{OUT}=0mA)

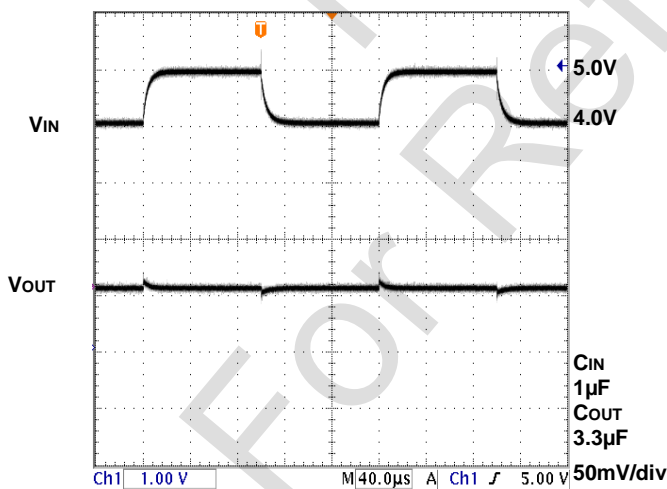

LINE TRANSIENT (I_{OUT}=10mA)

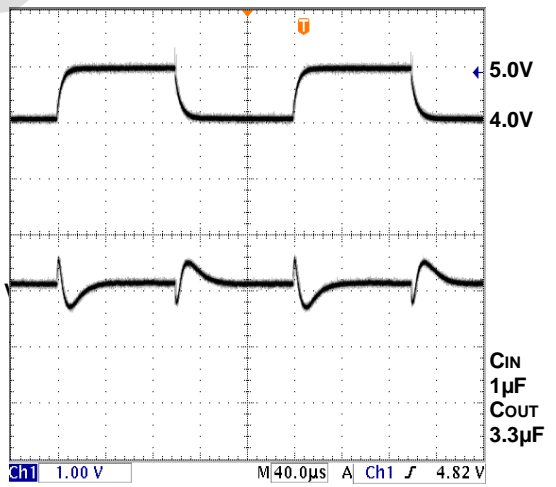

LINE TRANSIENT (I_{OUT}=200mA)

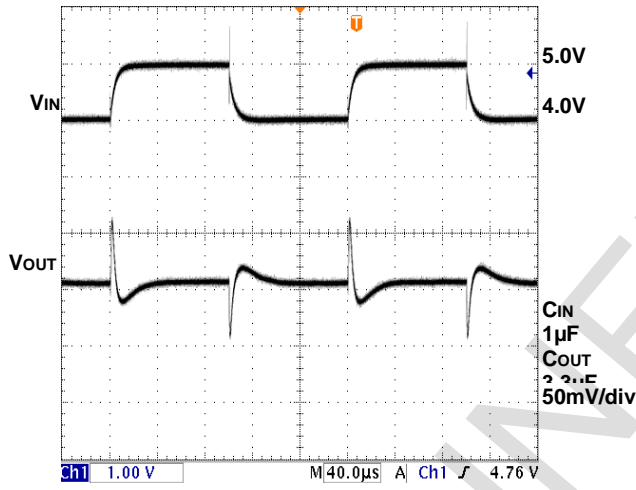

LINE TRANSIENT (I_{OUT}=300mA)

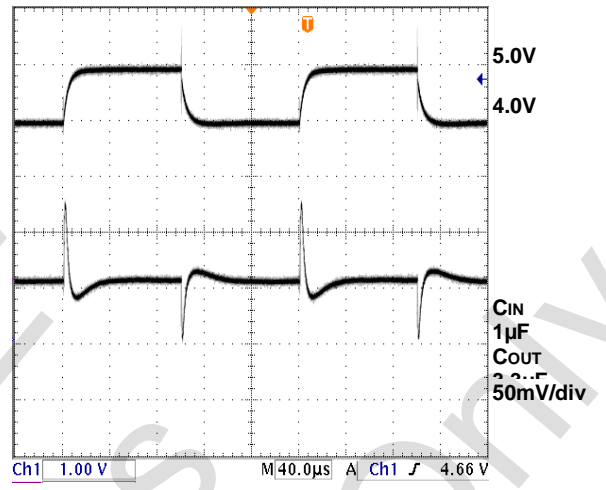

LOAD TRANSIENT

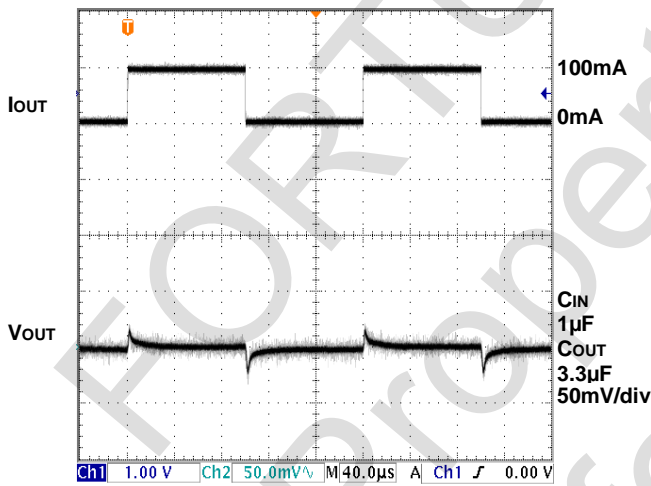

LOAD TRANSIENT

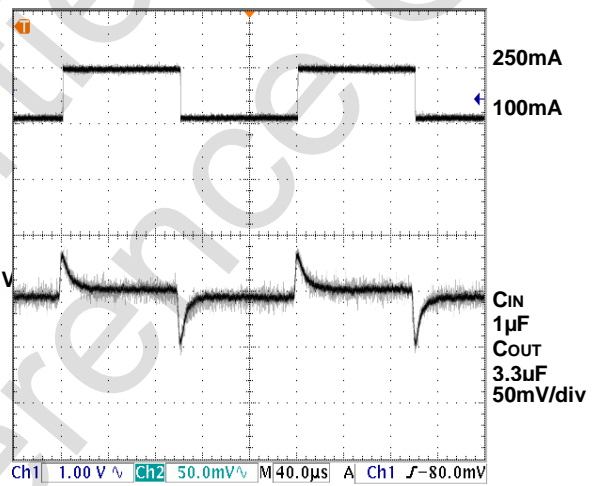

LOAD TRANSIENT

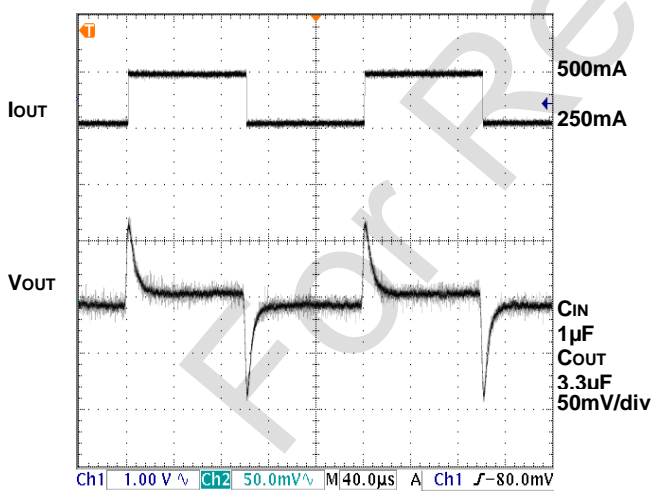

LOAD TRANSIENT

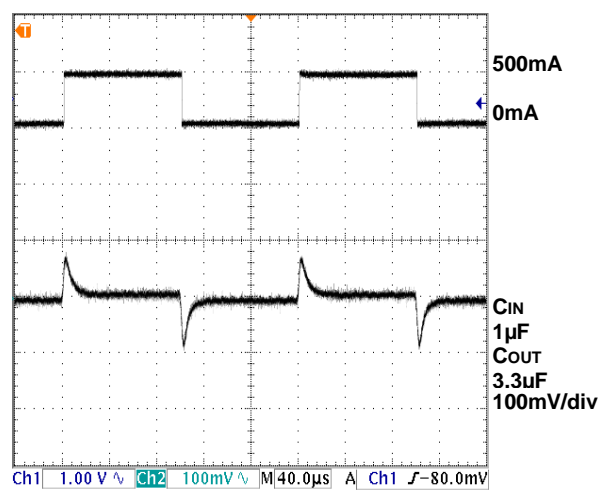

13. Detail Description

The FS8855 is a low-dropout linear regulator. The device provides preset 2.5V and 3.3V output voltages for output current up to 500mA. Other mask options for special output voltages from 1.5V to 5.0V with 100mV increment are also available. As illustrated in function block diagram, it consists of a 1.25V reference, error amplifier, P-channel pass transistor and an internal feedback voltage divider.

The 1.25V bandgap reference is connected to the error amplifier, which compares this reference with the feedback voltage and amplifies the voltage difference. If the feedback voltage is lower than the reference voltage, the pass-transistor gate is pulled lower, which allows more current to pass to the output pin and increases the output voltage. If the feedback voltage is too high, the pass-transistor gate is pulled up to decrease the output voltage.

The output voltage is feedback through an internal resistive divider connected to OUT pin. Additional blocks include an output current limiter, thermal sensor, and shutdown logic.

Internal P-channel Pass Transistor

The FS8855 features a P-channel MOSFET pass transistor. Unlike similar designs using PNP pass transistors, P-channel MOSFETs require no base drive, which reduces ground pin current. PNP-based regulators also waste considerable current in dropout when the pass transistor saturates, and use high base-drive currents under large loads. The FS8855 does not suffer from these problems and consumes only 30µA (Typ.) of ground pin current under heavy loads as well as in dropout conditions.

Output Voltage Selection

The FS8855 output voltage is preset at an internally trimmed voltage 2.5V, 3.3V or can be mask-optioned from 1.5V to 5.0V with 100mV increment. The first two digits of part number suffix identify the output voltage (see Ordering Information). For example, the FS8855-33CL has a preset 3.3V output voltage.

Current Limit

The FS8855 also includes a fold back current limiter. It monitors and controls the pass transistor's gate voltage, estimates the output current, and limits the output current within 0.8A.

Thermal Overload Protection

Thermal overload protection limits total power dissipation in the FS8855. When the junction temperature exceeds $T_J = +155^\circ\text{C}$, a thermal sensor turns off the pass transistor, allowing the IC to cool down. The thermal sensor turns the pass transistor on again after the junction temperature cools down by 10°C , resulting in a pulsed output during continuous thermal overload conditions.

Thermal overload protection is designed to protect the FS8855 in the event of fault conditions. For continuous operation, the maximum operating junction temperature rating of $T_J = +125^\circ\text{C}$ should not be exceeded.

Operating Region and Power Dissipation

Maximum power dissipation of the FS8855 depends on the thermal resistance of the case and circuit board, the temperature difference between the die junction and ambient air, and the rate of airflow. The power dissipation across the devices is $P = I_{OUT} \times (V_{IN} - V_{OUT})$. The resulting maximum power dissipation is:

$$P_{MAX} = \frac{(T_J - T_A)}{\theta_{JC} + \theta_{CA}} = \frac{(T_J - T_A)}{\theta_{JA}}$$

Where $(T_J - T_A)$ is the temperature difference between the FS8855 die junction and the surrounding air, θ_{JC} is the thermal resistance of the package chosen, and θ_{CA} is the thermal resistance through the printed circuit board, copper traces and other materials to the surrounding air. For better heat-sinking, the copper area should be equally shared between the IN, OUT, and GND pins.

If the FS8855 uses a SOT-89 package and this package is mounted on a double sided printed circuit board with two square inches of copper allocated for “heat spreading”, the resulting θ_{JA} is 180°C/W.

Based on a maximum operating junction temperature 125°C with an ambient temperature of 25°C, the maximum power dissipation will be:

$$P_{MAX} = \frac{(T_J - T_A)}{\theta_{JC} + \theta_{CA}} = \frac{(125 - 25)}{180} = 0.555W$$

Thermal characteristics were measured using a double sided board with 1” x 2” square inches of copper area connected to the GND pin for “heat spreading”.

Input-Output Voltage

A regulator’s minimum input-output voltage differential, or dropout voltage, determines the lowest usable supply voltage. In battery-powered systems, this will determine the useful end-of-life battery voltage. The FS8855 uses a P-channel MOSFET pass transistor, its dropout voltage is a function of drain-to-source on-resistance (RDS(ON)) multiplied by the load current.

$$V_{DROPOUT} = V_{IN} - V_{OUT} = R_{DS(ON)} \times I_{OUT}$$

14. Package Outline

SOT-89

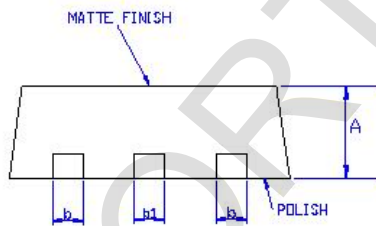
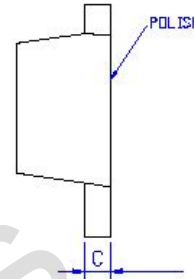
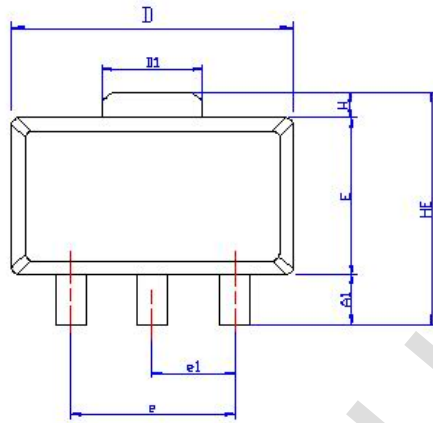

SYMBOLS	DIMENSIONS IN MILLIMETERS			DIMENSIONS IN INCHES		
	MIN	NOM	MAX	MIN	NOM	MAX
A	1.40	1.50	1.60	0.055	0.059	0.063
A1	0.80	1.04	—	0.031	0.041	—
b	0.36	0.42	0.48	0.014	0.016	0.018
b1	0.41	0.47	0.53	0.016	0.018	0.020
C	0.38	0.40	0.43	0.014	0.015	0.017
D	4.40	4.50	4.60	0.173	0.177	0.181
D1	1.40	1.60	1.75	0.055	0.062	0.069
HE	—	—	4.25	—	—	0.167
E	2.40	2.50	2.60	0.094	0.098	0.102
e	2.90	3.00	3.10	0.114	0.118	0.122
H	0.35	0.40	0.45	0.014	0.016	0.018
h	0.65	0.75	0.85	0.026	0.030	0.034
e1	1.40	1.50	1.60	0.054	0.059	0.063

15. Revision History

Ver.	Date	Page	Description
1.1	2003/05/09	5	Electrical Characteristics : Cancel example VOUT=3.3V, and show the whole range of VOUT (Fixed Voltage Type VOUT=1.3V~4.5V)
1.1	2003/05/09	6	Typical Operating Characteristics : Cancel example VOUT=3.3V, and show the whole range of VOUT (Fixed Voltage Type VOUT=1.3V~4.5V)
1.2	2003/12/12	1	General Description : Change "But for FS8855-19Cx, the output is 1.85V. For FS8855-29Cx, the output is 2.85V." to "except FS8855-29Cx which has 2.85V output voltage."
1.2	2003/12/12	1	Features : Change "Low dropout voltage 600mV at 500mA" to "Low dropout voltage 650mV at 500mA"
1.2	2003/12/12	1	Ordering Information : Change 1.85V option to 1.9V.
1.2	2003/12/22	5	Electrical Characteristics : Change dropout voltage at Iout=500mA from 600mV to 650mV.
1.3	2004/03/16	1	General Description : Correct wording.
1.3	2004/03/16	3	Pin description : Correct wording.
1.3	2004/03/16	3	Change Function Block Diagrams to Functional Block Diagrams.
1.3	2004/03/16	4	Change Typical Application Schematic to Typical Application

Ver.	Date	Page	Description
			Circuit.
1.3	2004/03/16	4	Absolute Maximum Ratings : Remove Operating ambient temperature range.
1.3	2004/03/16	5	Electrical Characteristics : Add Symbol column.
1.3	2004/03/16	6	Typical Operating Characteristics : Change all labels "TEMPERATURE" to "AMBIENT TEMPERATURE". Current header "Ron vs. LOAD CURRENT"
1.3	2004/03/16	9/10	Detail Description : Correct wording.
1.3	2004/03/16	11	Change Package Information to Package Outline
1.3	2004/03/16	11/12 /13	Package Outline : Update SOT-223/SOT-89/TO-92 package diagrams.
1.3	2004/03/16	All	Update page header and footer to standard format. Update page layout and style to standard format.
1.4	2004/05/11	1	Ordering Information: Add Pb/P free package option
1.4	2004/05/11	2	Package Marking Information: Add Pb/P free package marking information
1.4	2004/05/11	4	Absolute Maximum Rating: Change continuous power dissipation values and add notes. Add maximum junction temperature +155°C.
1.4	2004/05/11	5	Electrical Characteristics: Change thermal shutdown temperature from 170°C to 155°C.
1.4	2004/05/11	5	Electrical Characteristics: Change thermal resistance of SOT-223 from 80 to 155. Change thermal resistance of SOT-89 from 150 to 180. Change thermal resistance of TO-92 from 220 to 180.
1.4	2004/05/11	10	Operating Region and Power Dissipation: Change the result of power dissipation calculation example for SOT-89. The calculated value is based on new thermal resistance and recommended operating temperature range.
2.0	2005/08/26	All	Update header/footer with new format.
2.0	2005/08/26	1	General Description: Update output voltages from "1.3V~4.5V" to "1.5V~5.0V". Remove SOT-223 package.
2.0	2005/08/26	1	Features: Update output voltages from "1.3V~4.5V" to "1.5V~5.0V". Add "Quiescent current 30µA at 5V input."
2.0	2005/08/26	1	Ordering Information: Delete D,F,W,G,H,J,X pin-out types. Update output voltages from "1.3V~4.5V" to "1.5V~5.0V".
2.0	2005/08/26	2	Pin Configurations: Delete D,F,W,G,H,J,X pin-out types.
2.0	2005/08/26	2	Pin description: Delete D,F,W,G,H,J,X pin-out types. Move pin descriptions into table.
2.0	2005/08/26	3	Typical Application Circuit: Update pin-out and connection diagram.
2.0	2005/08/26	4	Electrical Characteristics: Remove output voltage spec. Add the output voltage accuracy spec. for $3.5 < V_{OUT} \leq 5.0$ range to +/-1% at 7V input, and +/- 1.5% at 9V input Change the dropout voltage spec. at 1mA from "Typ 1.0mA Max 1.2mA" to "Typ 1.1mA Max 1.3mA". Change the dropout voltage spec. at 100mA from "Typ 100mA Max 120mA" to "Typ 120mA Max 145mA". Change the ground pin current spec. from "Typ 65µA Max 120µA" to "Typ 30µA Max 50µA". Change the test condition for previous two spec. to $V_{in}=5.0V$. Change PSRR spec. from "75dB @ 10KHz" to "70dB @ 1KHz" Change thermal shutdown hysteresis spec. from 20 to 10.
2.0	2005/08/26	8	Detail Description: Update output voltages from "1.3V~4.5V" to "1.5V~5.0V". Update quiescent current from "65µA" to "30µA".
2.0	2005/08/26	10	Package Outline: Remove SOT-223 package information.
2.1	2006/09/27	All	Revise datasheet format
2.2	2009/08/05	3	Ordering Information:

Ver.	Date	Page	Description
			Update package L、I Update package type G stands for Green-Package Update Output Voltage 25 : 2.5V、33 : 3.3V
2.3	2009/12/09	6	Vin Absolute Max. Rating : 9V Vin Operating Range : 2.5~7V
2.4	2010/03/22	3,6	Revise Dropout Voltage 500mA : TYP 700mV MAX 850mV
2.5	2010/10/20	3	Add Output 1.5V
2.6	2011/01/31	3	Add Output 2.8V, 3.0V, 3.6V
2.7	2014/05/22	2	Revised company address

FORTUNE
 Properties
 For Reference Only